

# PL7100

HEAVY DUTY GRADE 1

COMMERCIAL PHONE LOCK WITH CLUTCH

COMPATIBLE WITH APPLE AND ANDROID PHONES



**MEETS**  
*The Buy American Act*



- ✓ **APPLE AND ANDROID COMPATIBLE**
- ✓ **BLE (BLUETOOTH LOW ENERGY) MANAGEMENT**
- ✓ **OPTIONAL GATEWAY CONNECTIVITY**  
(REMOTE MANAGEMENT THROUGH THE INTERNET)
- ✓ **PROXIMITY RFID CARD (13.56 MHz) STANDARD**
- ✓ **DIGITAL TOUCHSCREEN**
- ✓ **TIMESTAMPED ACCESS LOG (AUDIT TRAIL)**
- ✓ **RFID KEY FOB (OPTIONAL)**
- ✓ **1 ADMIN PHONE, 49 CLIENT PHONES PER LOCK**
- ✓ **50 DIGITAL TOUCHSCREEN COMBINATIONS PER LOCK**
- ✓ **50 RFID CARDS / KEY FOBs PER LOCK**
- ✓ **1 ADMIN PHONE CAN MANAGE UP TO 250 LOCKS**
- ✓ **10,000 AUDIT TRAIL ENTRIES**
- ✓ **REMOTE SWITCH CONNECTOR**
- ✓ **EMERGENCY KEY OVERRIDE**
- ✓ **ALARM SYSTEM CONNECTOR**
- ✓ **INDIVIDUAL USER ACCESS MODE**
- ✓ **PASSAGE MODE**
- ✓ **WEATHER RESISTANT**
- ✓ **BUZZER & LED INDICATORS**
- ✓ **ANTI-TAMPER LOCKOUT**
- ✓ **LOW BATTERY WARNING**
- ✓ **EMERGENCY CHARGE INTERFACE**
- ✓ **CLUTCH TECHNOLOGY**
- ✓ **NON-HANDED, REVERSIBLE**
- ✓ **2 YEAR WARRANTY**



RFID CARD



RFID KEY FOB (optional)

CLUTCH



BLEGW-99 (optional) Internet to Bluetooth signal converter (BRIDGE)



9V EMERGENCY BATTERY PORT



Meets ADA requirements  
Specially designed for  
Barrier Free Application  
Conforms with ANSI A156.2  
Series 4000, Grade 1 requirements  
Exceeds 1,000,000 cycles

## SPECIFICATIONS

### APPLICATIONS

For offices, schools, hospitals, apartments, hotel / motel, residential, commercial and public buildings.

### ANSI STANDARDS

Meets or exceeds BHMA / ANSI A 156.2 Series 4000 Grade 1 requirements.

### DOOR RANGES

1 3/8" to 1 3/4" thickness.

### BACKSET

2 3/4" Standard, 2 3/8", 3 3/4", 5" and 2 3/4" anti-friction latch with 3/4" throw for pair of fire doors optional.

### LATCH FACEPLATE

Standard 2 3/4" x 1 1/8" for 2 3/4" backset.  
Optional 2 1/4" x 1 1/8" for 2 3/8" backset.

### PROXIMITY (RFID) CARD (STANDARD)

2 pcs. included. Compatible with existing MIFARE infrastructure. Operates at 13.56 MHz in accordance with ISO 14443A. Inductive distance up to 1 3/16".

### RFID KEYFOB (OPTIONAL)

Operates at 13.56 MHz in accordance with ISO 14443A. Inductive distance up to 1 3/16".

### POWER SUPPLY

4 AA 1.5V Alkaline Batteries (comes standard in packing).

### CLUTCH

Clutch technology allows turning of lever without retracting the latch. Thus prolonging the life of the lock by reducing stress on the spindle and other parts.

### CYLINDER & KEYWAYS

6 pin solid brass "C" keyway standard. Schlage E, Schlage C-K, Russwin D1-2-3-4, Corbin 59/60, Corbin-Russwin L4, Sargent LA-LB-LC, Falcon/Weiser E, Arrow A, Yale 8, Yale GA and Kwikset. Can also accept Medeco, Assa, Kaba and Cal-Royal (HSK) High Security Cylinders.

### WEATHER RESISTANT

All models are weather resistant for operating temperature ranges of +149°F to -4°F (+65°C to -20°C) and storage temperature ranges of +176°F to -22°F (+80°C to -30°C).

### BLUETOOTH CONNECTIVITY

Lock can be managed / synced using the K3 (Apple) and K3+ (Android) app.

### ACCESS LOG (AUDIT TRAIL)

The K3 app features a 24 / 7 activity log, so you can keep track of who accessed the lock. A timestamped access log can be shared by the Admin phone via email. 10,000 audit trail entries.

### STRIKES

ASA strike standard, "T" and full lip strikes available on request.

### BLE GATEWAY CONNECTIVITY

Remote access / management of locks through the internet.



**MEETS**  
The Buy American Act



PL7100

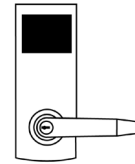

## FUNCTIONS

Latch bolt operated by lever from either side, except outside has to use a pre-programmed RFID card or a registered smart phone to touch the face of the face lock in order to retract the latch upon turning the lever. Key overrides the use of the RFID card and smartphone.

## FEATURES

- **Apple and Android Compatible** – iPhone 4S or above with iOS 8.0 and above. Android 4.3 or above with Bluetooth Low Energy capability.
- **Gateway Connectivity** – optional gateway device to connect compatible locks to the internet, so users can manage locks remotely.
- **Bluetooth Connectivity** – lock can be managed / synced using the K3 (Apple) and K3 (Android phones without NFC), and K3+ (Android phones with NFC) app.
- **NFC (Near Field Communication) Interface** – NFC compatible for android phones. For the complete list of phones, please go to link: [www.nfcworld.com/nfc-phones-list/#available](http://www.nfcworld.com/nfc-phones-list/#available)
- **Admin Phone** – a lock can only have one Administrator phone at a time. Only smartphones are used as Administrator. One admin phone can manage up to 250 locks.
- **Access Log (Audit Trail)** – the K3 app features a 24 / 7 activity log, so you can keep track of who accessed the lock. A timestamped access log can be shared by the Admin phone via email. 10,000 audit trail entries.
- **Passage Mode** – once enabled by the Admin, the unit is unlocked continuously until “Disable Passage Mode” is initiated.
- **Tones and LED Indicators** – indicates the operating status of the lock accompanied by the corresponding tones / beeps.
- **Restricted Access Right** – PL7100 can be programmed to specify the access period or intervals of users.
- **Keypad Anti-Tamper Lockout** – if an invalid code is entered 3 times consecutively, the unit will alarm 10 beeps and stay idle for 1 minute.
- **Remote Switch / Release** – PL7100 provides 2 remote switches. Either can be used for an emergency push button switch, or can be connected to alarm systems / fire alarms.
- **RFID Card (Standard)** – compatible with existing MIFARE infrastructure. Operates at 13.56 MHz in accordance with ISO 14443A. Inductive distance up to 1 3/16”.
- **RFID KEY FOB (Optional)** – compatible with existing MIFARE infrastructure. Operates at 13.56 MHz in accordance with ISO 14443A. Inductive distance up to 1 3/16”.
- **Weather Resistant** – the PL7100 is designed to make sure that internal electronic parts are protected from moisture, dust, water and corrosion. All models are weather resistant with operating temperature of +149°F to -4°F (+65°C to -20°C) and storage temperature of +176°F to -22°F (+80°C to -30°C).
- **Low Battery Warning** – when voltage is lower than safety power, PL7100 gives beep sound warnings after unlocking the device.
- **Clutch Technology** – the outside lever of the PL7100 is a free-wheeling lever. If no valid code is entered, the lever will just turn freely without moving any parts inside. Thus, preventing breaking or tampering.
- **Non-Handed** – PL7100 is reversible for left and right hand openings.

## FINISHES AVAILABLE

BHMA SYMBOL	US CODE	DESCRIPTION
626	US26D	Satin Chrome
613	US10B	Oil Rubbed Bronze
606	US4	Satin Brass
605	US3	Bright Brass
625	US26	Bright Chrome

Refer to price list for stock finishes and functions

## TECHNICAL SPECS

Operating Voltage	4x AA 1.5V Alkaline
Operating Temperature	+149°F to -4°F (+65°C to -20°C)
Storage Temperature	+176°F to -22°F (+80°C to -30°C)
Operating Humidity	5% to 95% relative humidity; non-condensing
Transmit Frequency	13.56 MHz
User ID Capacity	1 Admin + 49 Client Phones + 50 Digital Touch Screen Combinations + 50 (Cards / Key Fobs)

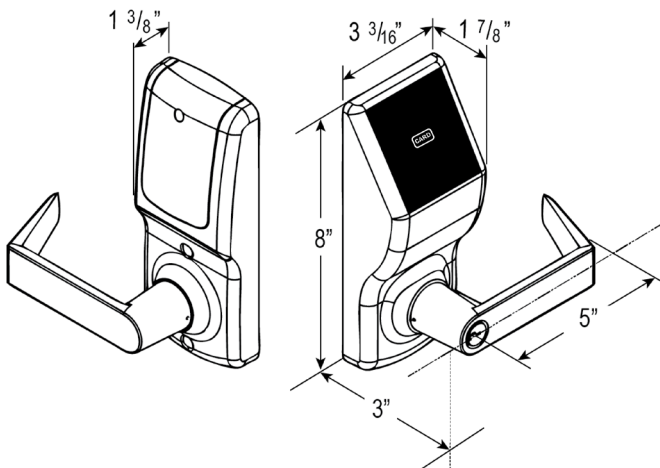

## DOOR PREPARATION

