

INSTRUCTIONS FOR INSTALLATION OF ENTRANCE LOCKS IN NEW DOORS OR THE REPLACEMENT OF EXISTING LOCKS

FOR USE ON DOORS 1-3/8" TO 1-3/4" (35mm~45mm) THICK

TOOLS REQUIRED FOR NEW INSTALLATION

- 1 phillips head screwdriver
- 1 2-1/8" (54mm) hole saw
- 1 1" (25.4mm) drill bit
- 1 chisel

TOOLS REQUIRED FOR REPLACEMENT INSTALLATION:

- 1 phillips head screwdriver

FOLLOW ALL STEPS FOR REPLACEMENT OR NEW CONSTRUCTION.

FOLLOW STEPS 3C, 4C, 5, 6, 7, 8, 9 and 10 FOR DO-IT-YOURSELF REPLACEMENT AFTER REMOVAL OF EXISTING LOCK.

REPLACING EXISTING LOCKS:

Before beginning, measure from centre of lock to door edge in order to check length of backset on existing lock.

The backset length of new lock is stated clearly on front of package. If backset size is the same, continue; otherwise, you'll have to replace lock with proper size backset. Some models are supplied with adjustable latch which can fit 2-3/8" (60mm) or 2-3/4" (70mm) backset. The adjustable latch was preset to 2-3/8" (60mm) at factory. If 2-3/4" (70mm) is required, please follow the steps shown below.

ILLUSTRATIONS ARE SHOWN WITH ENTRANCE MODELS. INSTALLATION IS SAME FOR PRIVACY AND PASSAGE MODELS AS WELL.

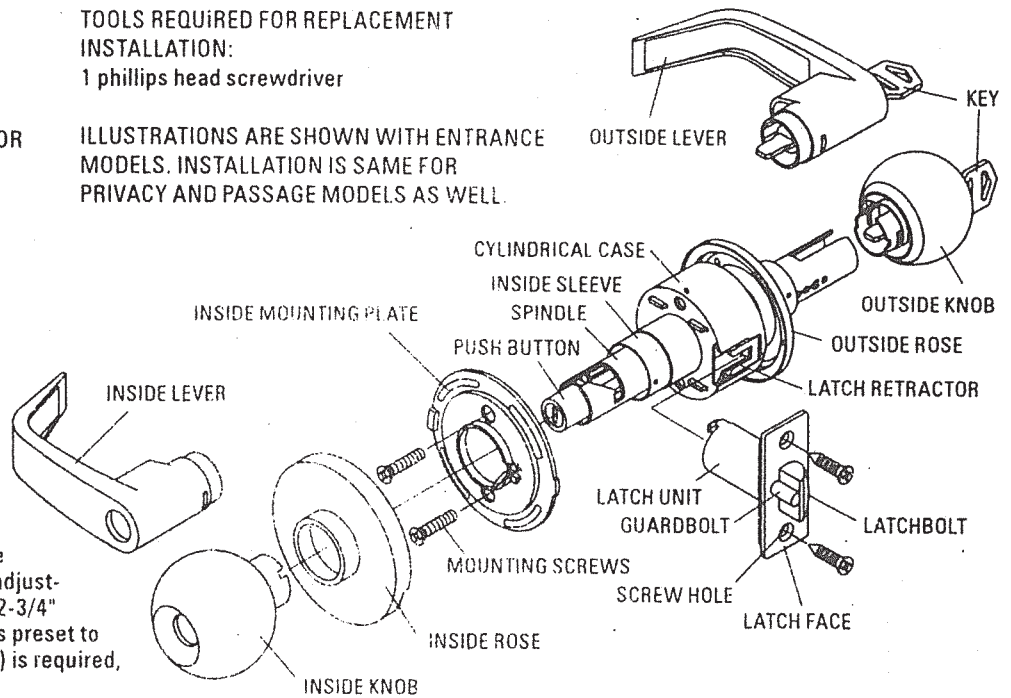

INSTALLATION INSTRUCTIONS

<p>1. MARK DOOR</p> <p>MARK FOR 1" (25.4mm) HOLE IN DOOR EDGE</p> <p>MARK FOR 2-1/8" (54mm) HOLE ON DOOR FACE</p> <p>Start approximately 36" (914mm) from floor. Fold and apply template to edge of door and mark centre of door edge as indicated on template. Mark centre hole on door face through guide on template.</p> <p>(NOTE: Backset on door face must be same as backset of lock.)</p>		<p>2. DRILL HOLES</p> <p>Drill 2-1/8" (54mm) hole through door face as marked for lockset. It is recommended that holes be drilled from both sides to prevent splitting. Drill 1" (25.4 mm) hole in centre of door edge for latch.</p> <p>2-1/8" (54mm) HOLE</p> <p>1" (25.4mm)</p>	
<p>3. INSTALL LATCH</p>			
<p>A</p> <p>Insert latch in hole keeping it parallel to face of door. Mark outline and remove latch.</p>		<p>B</p> <p>Chisel 1/8" (3mm) deep or until latch face is flush with door edge.</p>	
<p>C</p> <p>Insert latch and tighten screws. (NOTE: Latchbolt bevel must face to closing direction.)</p>			

4. INSTALL STRIKE

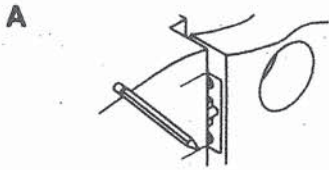

Close door until latchbolt touches jamb to locate strike in jamb and centre line of strike. Open door and extend line from mark to door stop. Measure one half of door thickness from door stop and vertically mark drill point centre for strike.

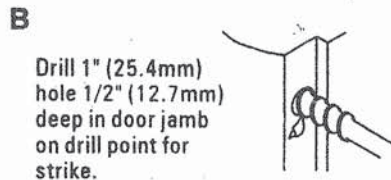

Drill 1" (25.4mm) hole 1/2" (12.7mm) deep in door jamb on drill point for strike.

CAUTION: To ensure proper lockset function. Hole in jamb must be drilled a full 1/2" (12.7mm) deep.

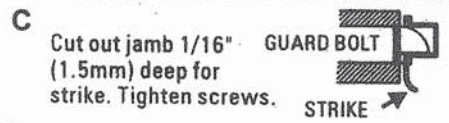

Cut out jamb 1/16" (1.5mm) deep for strike. Tighten screws.

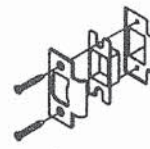

Guardbolt stops against strike, as illustrated, preventing forcing when door is closed. Adjustable tang on strike permits bending in or out to

eliminate too loose fit between door and door stop.

5. REMOVE INSIDE TRIM

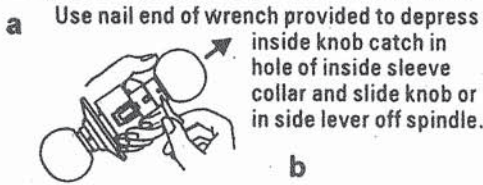

Use nail end of wrench provided to depress inside knob catch in hole of inside sleeve collar and slide knob or in side lever off spindle.



Depress spring attached to inside rose. Insert nail end of wrench into slot to remove inside rose plate.

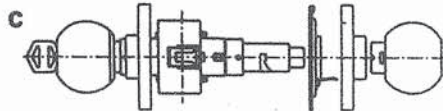

Remove inside rose and mounting plate.

6. ADJUST OUTSIDE ROSE

Adjust lock to fit door thickness by rotating outside rose. Lock will fit all doors 1-3/8" to 1-3/4" (35mm~45mm) thick.

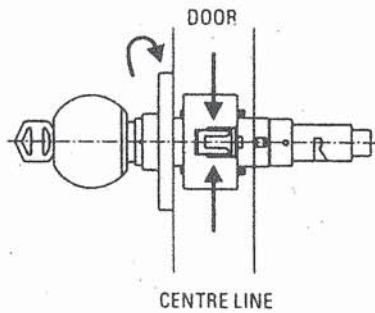

7. INSTALL LOCK

Latch unit must be in place before installing lock. Be sure lock housing engages with latch prongs and retractor interlocks with latch tail.

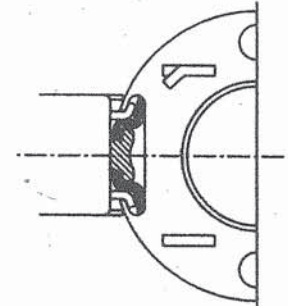

8. INSTALL INSIDE ROSE

Tighten machine screws securely to install mounting plate. Press rose onto mounting plate. Be sure to fit rose in recess of mounting plate.

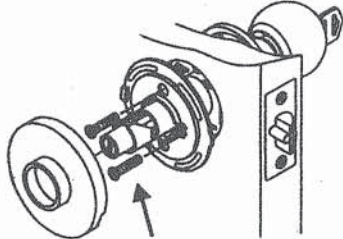

TIGHTEN MACHINE SCREWS SECURELY

9. INSTALLATION OF INSIDE KNOB OR INSIDE LEVER

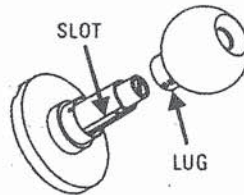

IMPORTANT- Align lug on knob with narrow slot on side of spindle and push knob all the way in until knob catch clicks into slot on knob. Otherwise knob will jamb on shaft.

To install inside lever, press down the lever catch in the hole with wrench and push inside lever all the way in until catch clicks into catch hole.

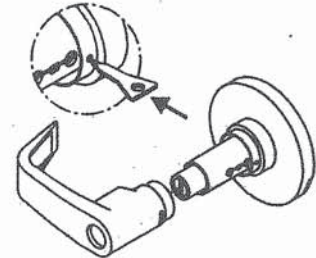

10. RIGHT KEY HOLE POSITION

Upon installation of the lock, it may happen that key hole faces upward or downward as shown in the following drawing. It is advisable to correct all key hole to be facing downward.



DOWNWARD
CORRECT ✓

UPWARD
INCORRECT X

11. IN ORDER TO ADJUST THE ABNORMAL STATE OF THE KEY HOLE FACING UPWARD, THE KNOB MUST BE PULLED OUT AND INSTALLED AGAIN. THE METHOD OF INSTALLATION IS DESCRIBED AS BELOW D.

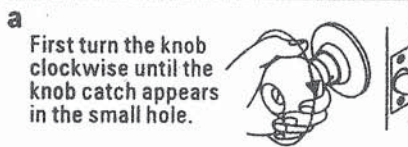

a First turn the knob clockwise until the knob catch appears in the small hole.

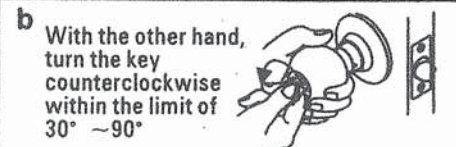

b With the other hand, turn the key counterclockwise within the limit of 30° ~90°

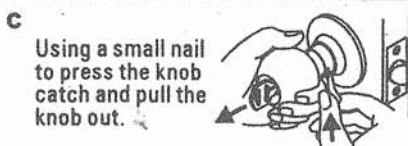

c Using a small nail to press the knob catch and pull the knob out.

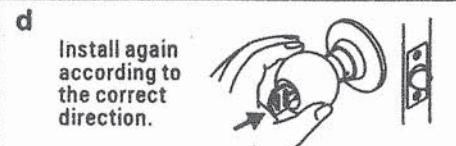

d Install again according to the correct direction.