

CB160 STANDARD DUTY DEADBOLTS
GL160 STANDARD DUTY GATE LATCHES
FOR STANDARD COMMERCIAL AND RESIDENTIAL APPLICATIONS

LIFETIME WARRANTY

Conforms with ANSI A156.5
Series 4000, Grade 2
Exceeds 20,000 cycles

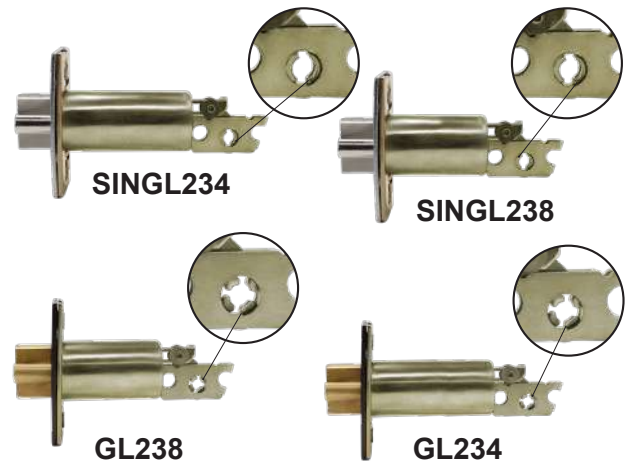
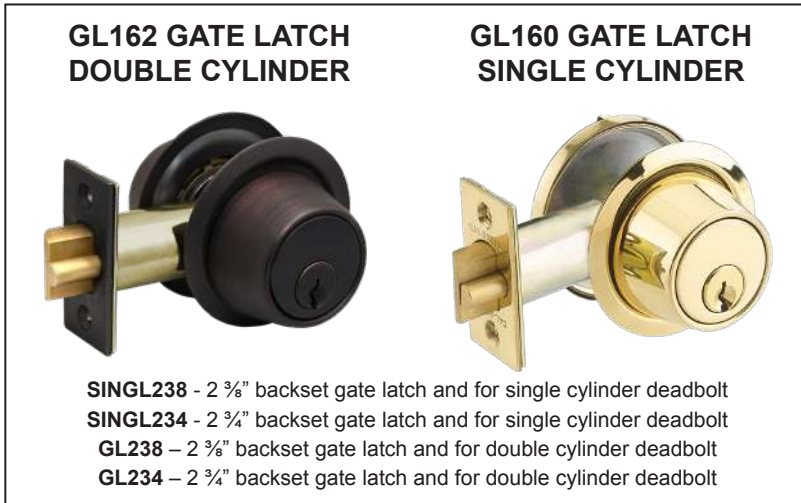
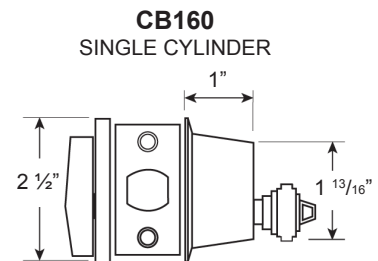
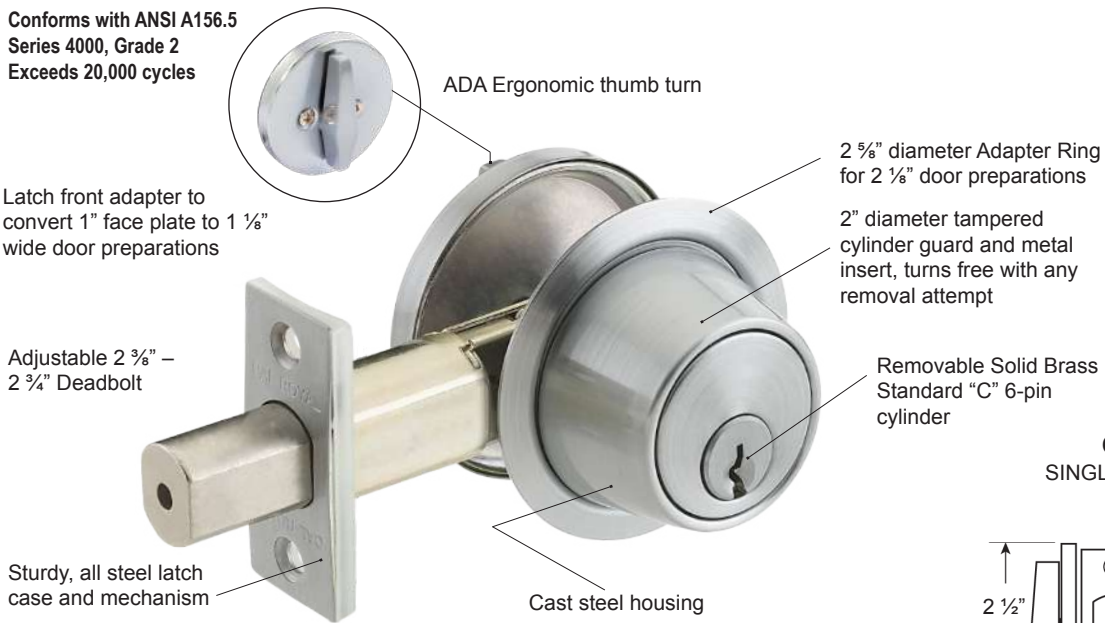

SPECIFICATIONS

TRIM

Wrought Brass or Stainless Steel.

DOOR RANGES

Adjustable 1 3/8" (35mm) to 1 3/4" (45mm) door thickness.

BACKSET

Adjustable 2 3/8" or 2 3/4".

DEADBOLT FACEPLATE

Latch bolt: Standard 2 1/4" x 1" packed with 1/8" plastic filler to convert 1" face plate to 1 1/8" wide door preparations.

BORE DIAMETER

1" for latch, 1 1/2" or 2 1/8" for lock housing.

STRIKE

1 1/8" x 2 3/4" square corner.

KEYWAYS

Standard 6-pin solid brass "C" keyway. Optional Schlage C-K composite with "E" keys, Schlage "E", Russwin D1-2-3-4, Corbin 59 / 60, Corbin-Russwin L4, Sargent LA-LB-LC, Falcon / Weiser E, Kwikset, Arrow A, Yale GA and Yale 8.

CB160 SERIES FINISHES AND FUNCTIONS



FINISHES AVAILABLE		
BHMA SYMBOL	US CODE	DESCRIPTION
605	US3	Polished Brass
606	US4	Satin Brass
609	US5	Antique Brass
612	US10	Satin Bronze
613	US10B	Oil Rubbed Bronze
619	US15	Satin Nickel
625	US26	Polished Chrome
626	US26D	Satin Chrome

Refer to price list for stock finishes and functions

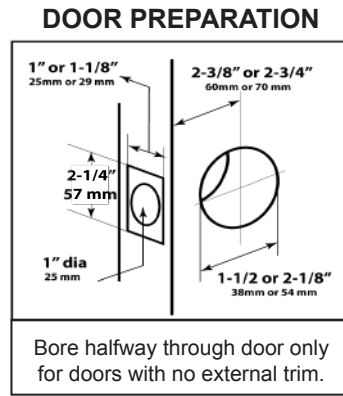

LIFETIME WARRANTY

CB160
ANSI E0152

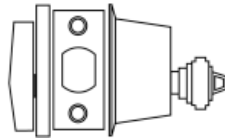

Standard Duty Single Cylinder Deadbolt
Deadbolt thrown or retracted by key from outside or by inside turn unit. Bolt automatically deadlocks when fully thrown.

CB162
ANSI E0142

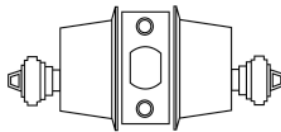

Standard Duty Double Cylinder Deadbolt
Deadbolt thrown or retracted by key from either side. Bolt automatically deadlocks when fully thrown.

GL160
ANSI E0152

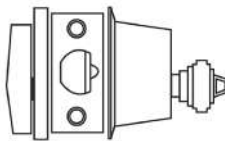

Single Cylinder Gate Latch (2 3/8" backset)
Dead locking latch bolt retracted by key from outside and thumb turn on inside. Otherwise always locked.

GL162
ANSI E0142

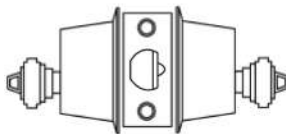

Double Cylinder Gate Latch (2 3/8" backset)
Dead locking latch bolt retracted by key from either side. Otherwise always locked.

GL160 / 234
ANSI E0152

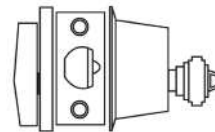

Single Cylinder Gate Latch (2 3/4" backset)
Dead locking latch bolt retracted by key from outside and thumb turn on inside. Otherwise always locked.

GL162234
ANSI E0142

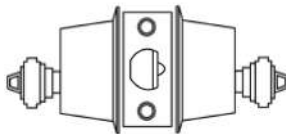

Double Cylinder Gate Latch (2 3/4" backset)
Dead locking latch bolt retracted by key from either side. Otherwise always locked.

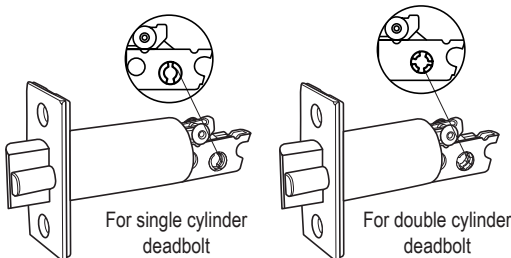

ADDITIONAL PARTS	
SINGL238	2 3/8" backset gate latch (1 1/8" x 2 1/4") for single cylinder deadbolt
SINGL234	2 3/4" backset gate latch (1 1/8" x 2 1/4") for single cylinder deadbolt
GL238	2 3/8" backset gate latch (1 1/8" x 2 1/4") for double cylinder deadbolt
GL234	2 3/4" backset gate latch (1 1/8" x 2 1/4") for double cylinder deadbolt

OTHER FUNCTIONS NOT LISTED ARE AVAILABLE UPON REQUEST
HOLD BACK FEATURE ON DEADBOLT WITH GATE LATCH NOT AVAILABLE